

Lumira Verticale - Locksets

LUMIRA VERTICALE

Technical features

- For 8-10 and 12 mm thick toughened glass
- To fit notch V370E
- With spring and dead bolt



V360

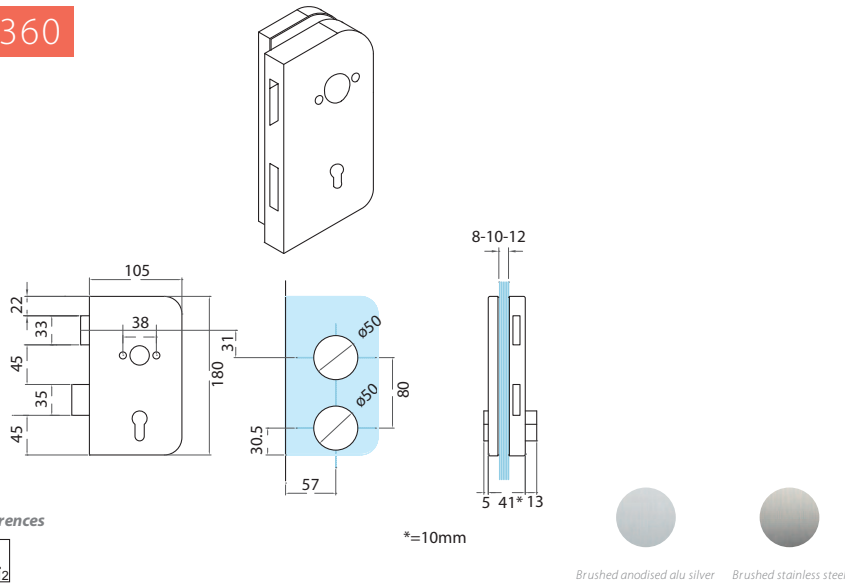

References



Lock for Euro profile cylinder without handles DIN right



Brushed anodised alu silver Brushed stainless steel

V360.12

V360.15

V370

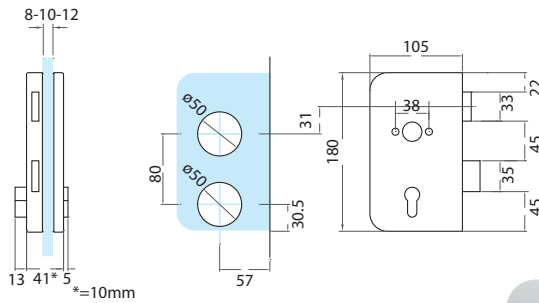
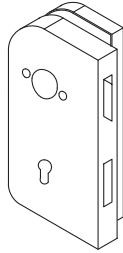

References



Brushed anodised alu silver

Brushed stainless steel

V370.12

V370.15

Lock for Euro profile cylinder without handles DIN left

V361

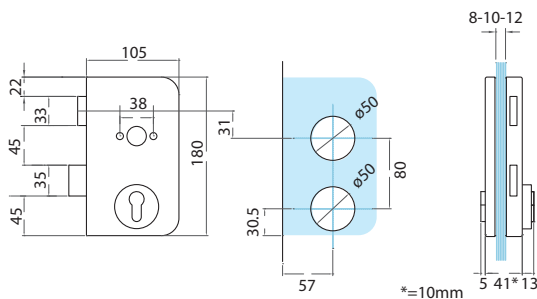
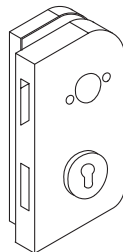

References



Brushed anodised alu silver

Brushed stainless steel

V361.12

V361.15

Lock for Euro profile cylinder without handles, with cylinder cover DIN right

V371

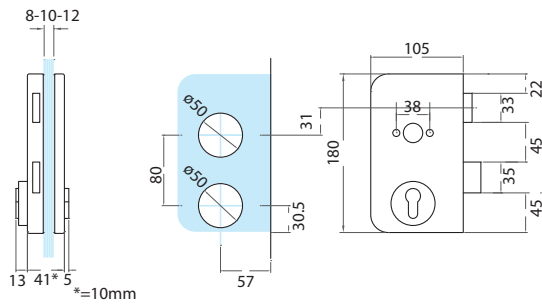
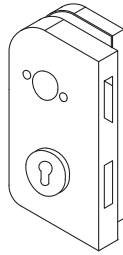

References



Lock for Euro profile cylinder without handles, with cylinder cover DIN left



Brushed anodised alu silver



Brushed stainless steel

V371.12

V371.15

V367

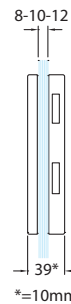
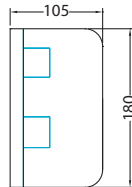
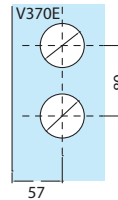
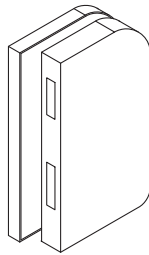

References



Matching patch keep for lock V370, V371 /DIN right



Brushed anodised alu silver



Brushed stainless steel

V367.12

V367.15

V377

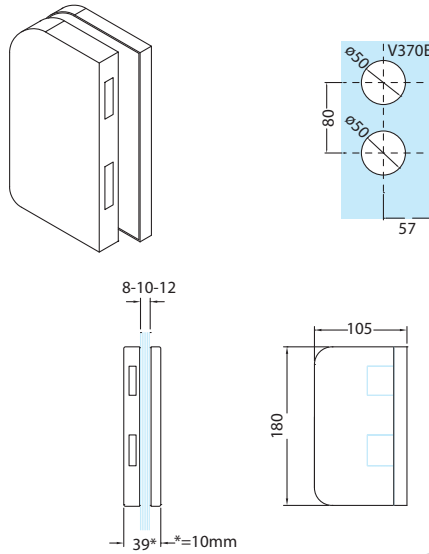

References



Matching patch keep for centre lock V360, V361 /DIN left

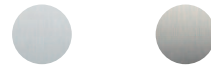

Brushed anodised alu silver Brushed stainless steel

V377.12

V377.15

V770

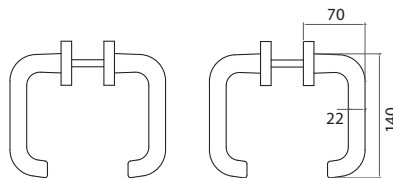

References

Pair of lever handles with rosettes for V360, V361, V370, and V371

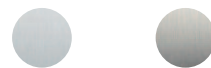

Brushed anodised alu silver Brushed stainless steel

V770.12

V770.15

V780

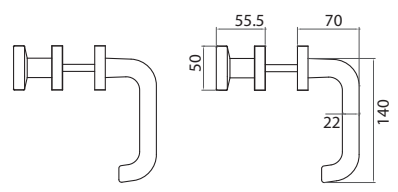

References

Brushed anodised alu silver Brushed stainless steel

V780.12

V780.15

Combination fixed knob / lever handle for V360, V361, V370 and V371

V533.1

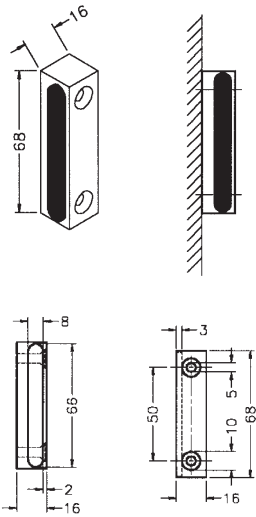

References

Polished varnished brass Brushed anodised alu silver Bright chromium Brushed matt chromium Brushed anodised alu.

V533.1.01

V533.1.12

V533.1.30

V533.1.33

V533.1.36

Wall stop for lock

V2140

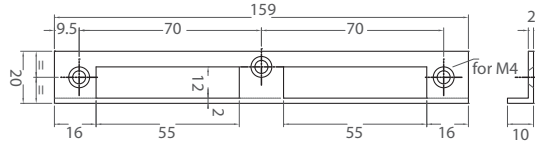

References

Keep plate L shape for V360, V361, V370, and V371



Brushed stainless steel

V2140.15

V2140.2

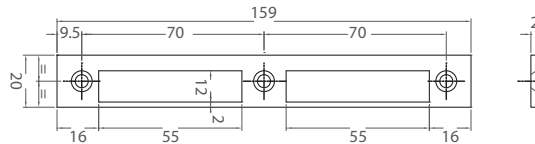

References

Keep plate for V360, V361, V370 and V371



Brushed stainless steel

V2140.2.15

V017

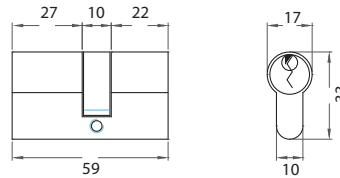

References



Europrofile cylinder 59 mm



Polished varnished brass



Bright chromium

V017.01

V017.30