

Handrail Supports and Accessories

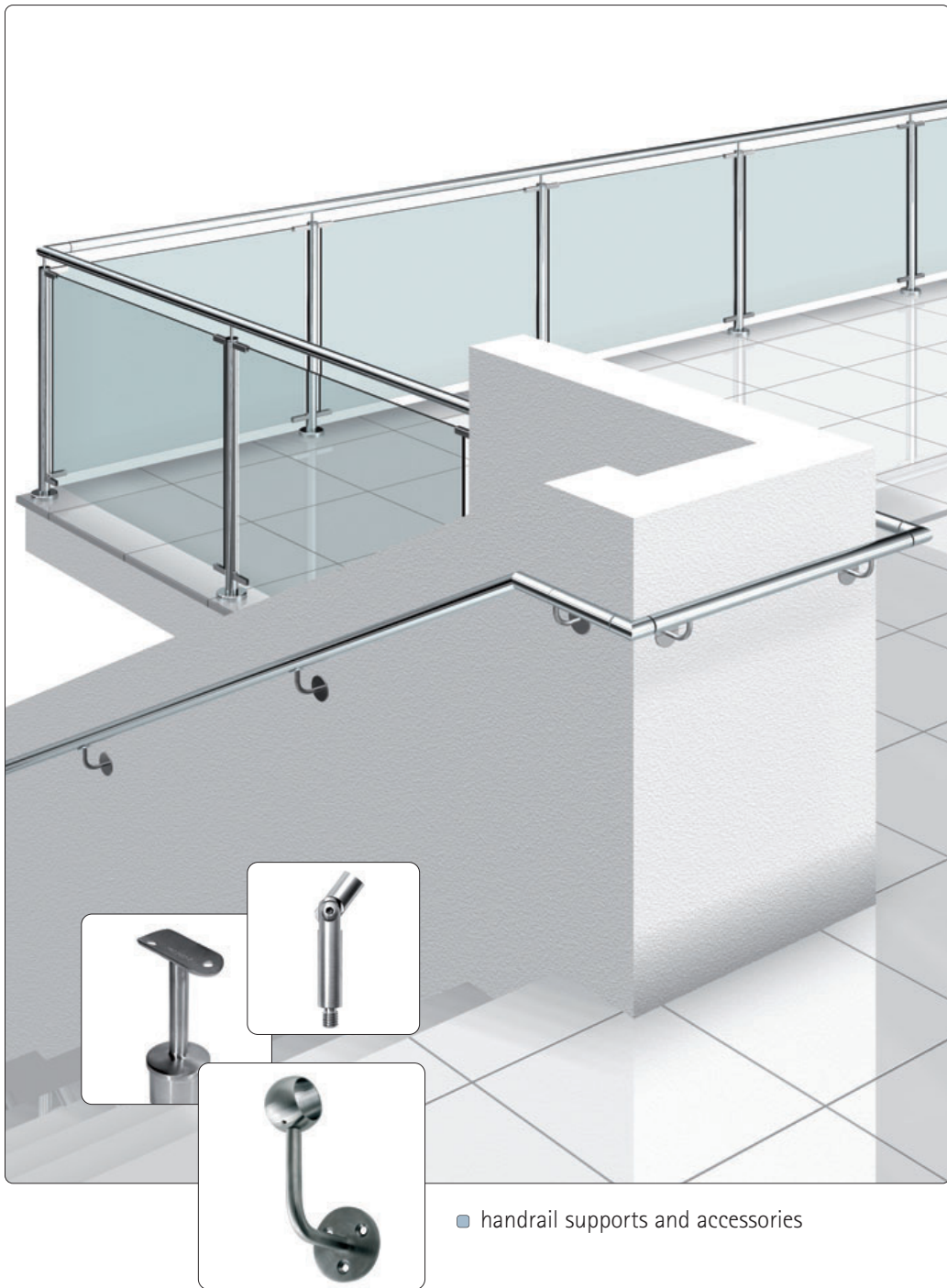

handrail supports and accessories

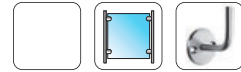

■ handrail support with round bar

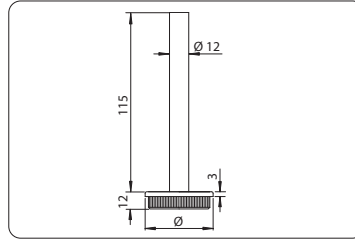

item no.	material	tube Ø	finish	
10201733A2	V2A (1.4301)	33,7 x 2,0	finish 240	2
10201742A2	V2A (1.4301)	42,4 x 2,0	finish 240	2

■ handrail support with round bar

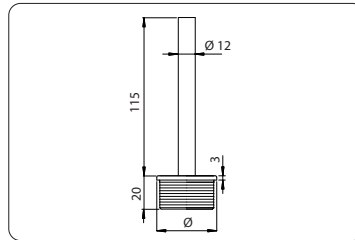

item no.	material	tube Ø	finish	
10201842A2	V2A (1.4301)	42,4 x 2,0	finish 240	2
10201942A2	V2A (1.4301)	42,4 x 2,6	finish 240	2





handrail supports and accessories

■ handrail support rigid, hollow

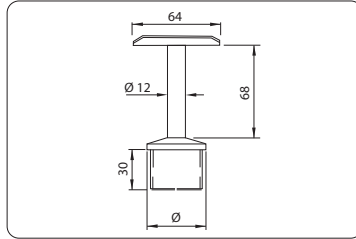

item no.	material	tube Ø	adapter	finish	
10202033A2	V2A (1.4301)	33,7 x 2,0	33,7 - 42,4	finish 240	2
10202042A2	V2A (1.4301)	42,4 x 2,0	33,7 - 42,4	finish 240	2
10202033A4	V4A	33,7 x 2,0	33,7 - 42,4	finish 240	2
10202033A4	V4A	42,4 x 2,0	33,7 - 42,4	finish 240	2

■ handrail support rigid, solid

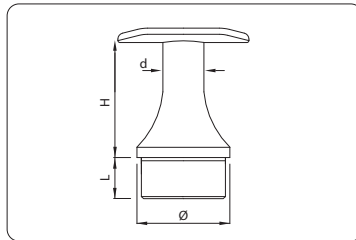

item no.	material	tube Ø	d	L	H	adapter	finish	
10202133A2	V2A (1.4301)	33,7 x 2,0	14	12	49	33,7 - 42,4	finish 240	2
10202142A2	V2A (1.4301)	42,4 x 2,0	20	10	58	33,7 - 42,4	finish 240	2

■ handrail support for side mounting

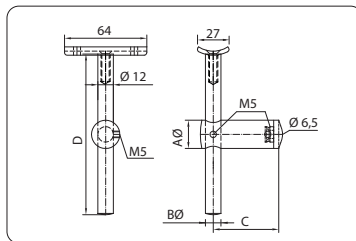

item no.	material	tube Ø	AØ	BØ	C	D	adapter	finish	
10202242A2	V2A (1.4301)	42,4	22	12	51	125	33,7 - 42,4	finish 240	2
10202342A2	V2A (1.4301)	42,4	24	14	80	100	33,7 - 42,4	finish 240	2

handrail supports and accessories

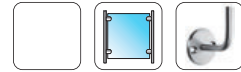

■ handrail support for side mounting, variable

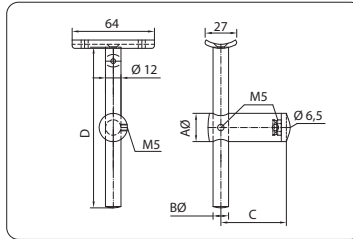

item no.	material	tube Ø	AØ	BØ	C	D	adapter	finish	
10202442A2	V2A (1.4301)	42,4	24	14	80	100	33,7 - 42,4	finish 240	2

■ handrail support variable, hollow

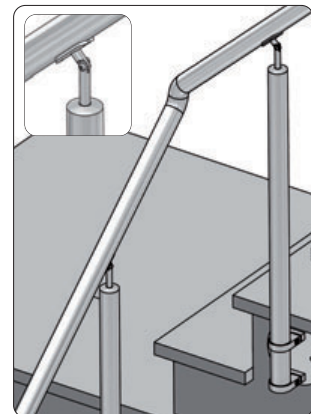
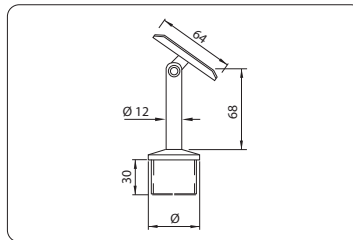

item no.	material	tube Ø	adapter	finish	
10202533A2	V2A (1.4301)	33,7 x 2,0	33,7 - 42,4	finish 240	2
10202542A2	V2A (1.4301)	42,4 x 2,0	33,7 - 42,4	finish 240	2
10202533A4	V4A	33,7 x 2,0	33,7 - 42,4	finish 240	2
10202542A4	V4A	42,4 x 2,0	33,7 - 42,4	finish 240	2

■ handrail support variable, solid

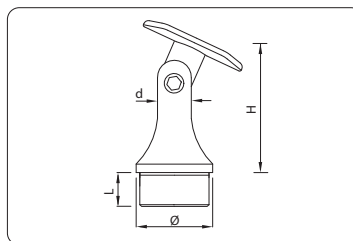

item no.	material	tube Ø	d	H	L	adapter	finish	
10202633A2	V2A (1.4301)	33,7 x 2,0	14	49	12	33,7 - 42,4	finish 240	2
10202642A2	V2A (1.4301)	42,4 x 2,0	20	49	15	33,7 - 42,4	finish 240	2





handrail supports and accessories

■ handrail support rigid, offset

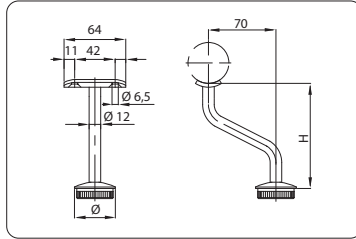

item no.	material	tube Ø	H	adapter	finish	
10202733A2	V2A (1.4301)	33,7 x 2,0	110	33,7 - 42,4	finish 240	2
10202742A2	V2A (1.4301)	42,4 x 2,0	110	33,7 - 42,4	finish 240	2
10202733A4	V4A	33,7 x 2,0	110	33,7 - 42,4	finish 240	2
10202742A4	V4A	42,4 x 2,0	110	33,7 - 42,4	finish 240	2

■ handrail support variable, offset

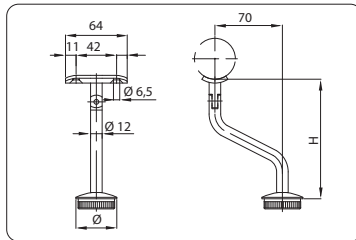

item no.	material	tube Ø	H	adapter	finish	
10202833A2	V2A (1.4301)	33,7 x 2,0	125	33,7 - 42,4	finish 240	2
10202842A2	V2A (1.4301)	42,4 x 2,0	125	33,7 - 42,4	finish 240	2
10202833A4	V4A	33,7 x 2,0	125	33,7 - 42,4	finish 240	2
10202842A4	V4A	42,4 x 2,0	125	33,7 - 42,4	finish 240	2

■ handrail support with ball ring, height adjustable with double joint

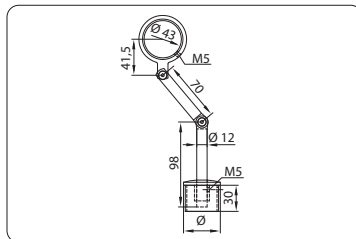

item no.	material	tube Ø	adapter	finish	
10202942A2	V2A (1.4301)	42,4 x 2,0	42,4 mm	finish 240	2

handrail supports and accessories



handrail support for welding

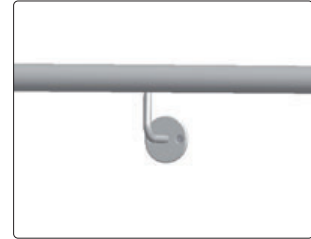
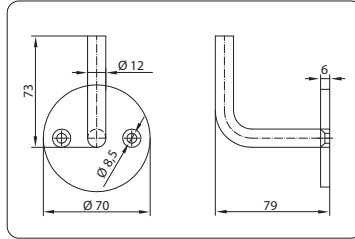

item no.	material	finish	
10203070A2	V2A (1.4301)	finish 240	2

handrail support for welding

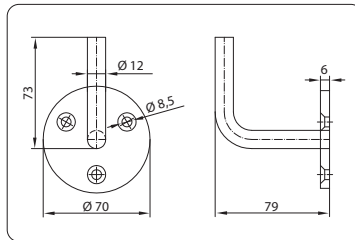

item no.	material	finish	
10203170A2	V2A (1.4301)	finish 240	2

handrail support variable

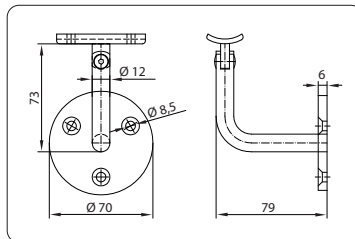

item no.	material	adapter	finish	
10203270A2	V2A (1.4301)	33,7 - 42,4	finish 240	2



handrail supports and accessories

■ handrail support with internal thread

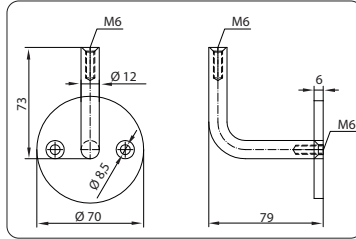

item no.	material	finish	
10203370A2	V2A (1.4301)	finish 240	2
10203370A4	V4A	finish 240	2

■ handrail support with internal thread

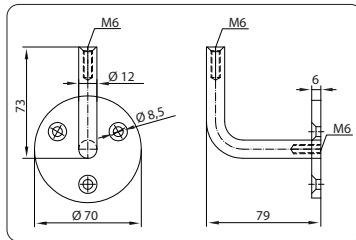

item no.	material	finish	
10203470A2	V2A (1.4301)	finish 240	2

■ handrail support rigid, laser cut

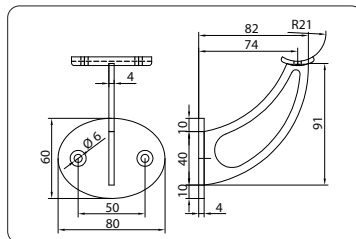

item no.	material	adapter	finish	
10203580A2	V2A (1.4301)	33,7 - 42,4	finish 240	2

handrail supports and accessories



- handrail support with internal thread for hanger bolt

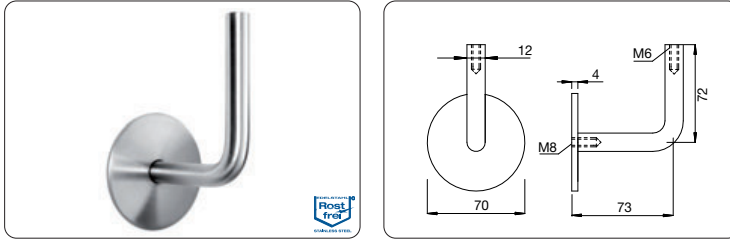

item no.	material	⊗	finish	🔁
10203664A2	V2A (1.4301)	M6/M8	finish 240	2

- handrail supports for glueing

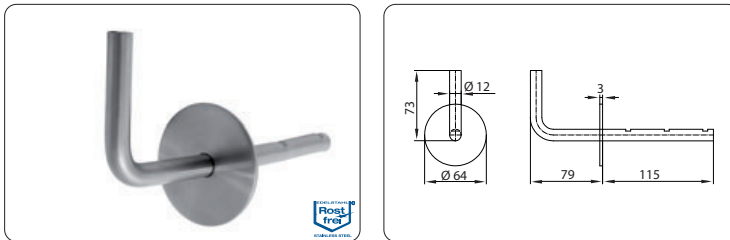

item no.	material	finish	🔁
10203764A2	V2A (1.4301)	finish 240	2

INFO

accessories
Art. Nr. 1960
compound mortar page 614

- handrail supports for glueing

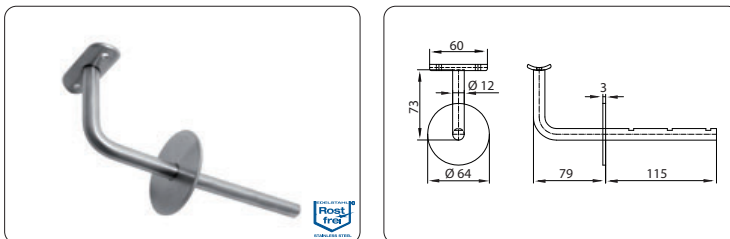

item no.	material	adapter	finish	🔁
10203864A2	V2A (1.4301)	33,7 - 42,4	finish 240	2

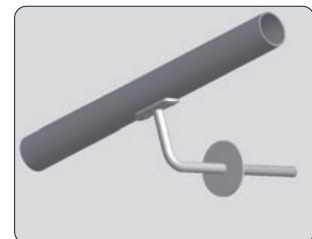



handrail supports and accessories

■ handrail supports for glueing

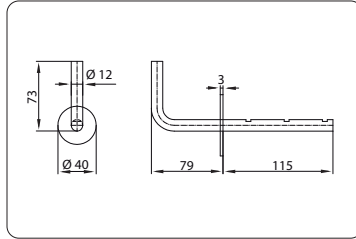

item no.	material	finish	
10203940A2	V2A (1.4301)	finish 240	2

■ handrail supports for glueing

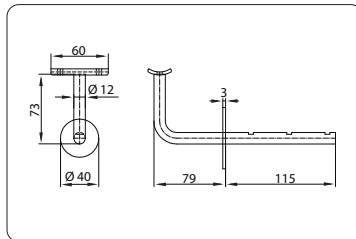

item no.	material	adapter	finish	
10204040A2	V2A (1.4301)	33,7 - 42,4	finish 240	2

■ handrail supports

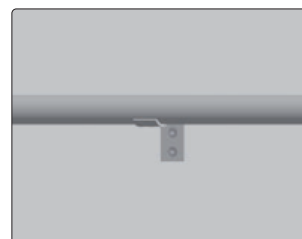
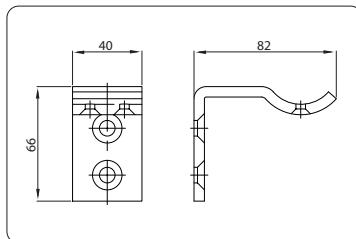

item no.	material	adapter	finish	
10204140A2	V2A (1.4301)	33,7 - 42,4	finish 240	2
10204140A4	V4A	33,7 - 42,4	finish 240	2

handrail supports and accessories



- handrail support height adjustable, with glass connector

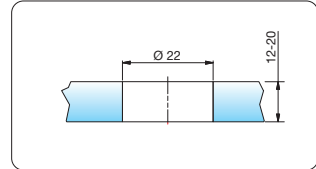
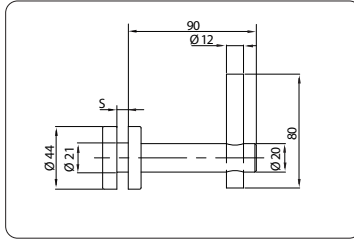
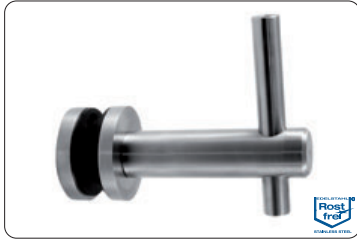

item no.	material	S	finish	
10204233A2	V2A (1.4301)	8 - 25	finish 240	2
10204233A4	V4A	8 - 25	finish 240	2

- handrail support rigid, with glass connector

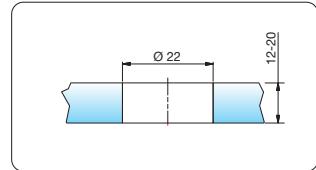
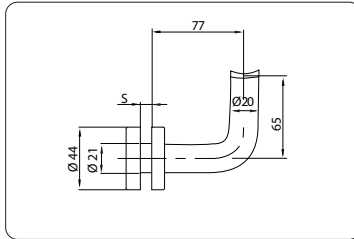

item no.	material	adapter	S	finish	
10204333A2	V2A (1.4301)	33,7 - 42,4	8 - 25	finish 240	2
10204333A4	V4A	33,7 - 42,4	8 - 25	finish 240	2

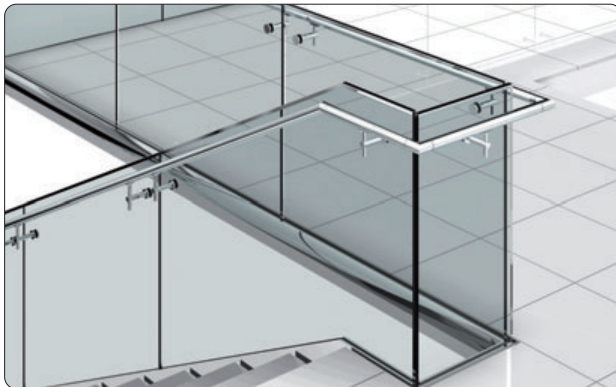



handrail supports and accessories

cover plate

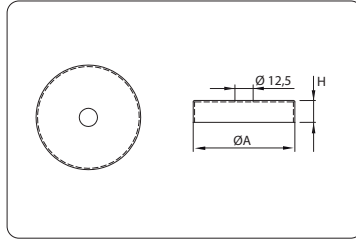

item no.	material	ØA	H	finish	
10204445A2	V2A (1.4301)	45	10	finish 240	2
10204470A2	V2A (1.4301)	70	12	finish 240	2
10204476A2	V2A (1.4301)	76	12	finish 240	2
10204476A4	V4A	76	12	finish 240	2

ball ring

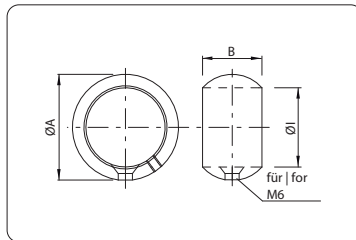

item no.	material	B	ØA	ØI	finish	
10204533A2	V2A (1.4301)	29,5	45	33,8	finish 240	2
10204542A2	V2A (1.4301)	29,5	55	42,5	finish 240	2
10204533A4	V4A	29,5	45	33,8	finish 240	2
10204542A4	V4A	29,5	55	42,5	finish 240	2



handrail supports and accessories



- end cap flat, with internal thread, hollow

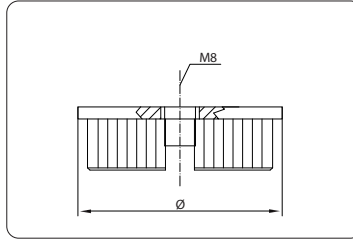
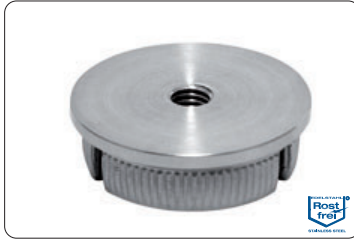

item no.	material	Ø	finish	
10204633A2	V2A (1.4301)	33,7 x 2,0	finish 240	2
10204642A2	V2A (1.4301)	42,4 x 2,0	finish 240	2
10204633A4	V4A	33,7 x 2,0	finish 240	2
10204642A4	V4A	42,4 x 2,0	finish 240	2

- end cap flat, with internal thread, solid

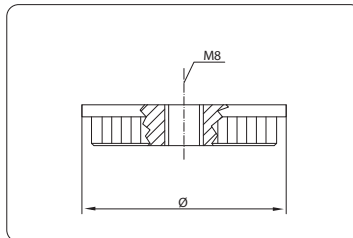

item no.	material	Ø	finish	
10204733A2	V2A (1.4301)	33,7 x 2,0	finish 240	2
10204742A2	V2A (1.4301)	42,4 x 2,0	finish 240	2
10204733A4	V4A	33,7 x 2,0	finish 240	2
10204742A4	V4A	42,4 x 2,0	finish 240	2



handrail supports and accessories

- end cap oval, with internal thread, hollow

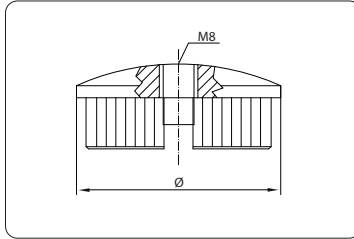

item no.	material	Ø	finish	
10204833A2	V2A (1.4301)	33,7 x 2,0	finish 240	2
10204842A2	V2A (1.4301)	42,4 x 2,0	finish 240	2
10204833A4	V4A	33,7 x 2,0	finish 240	2
10204842A4	V4A	42,4 x 2,0	finish 240	2

- end cap oval, with internal thread, solid

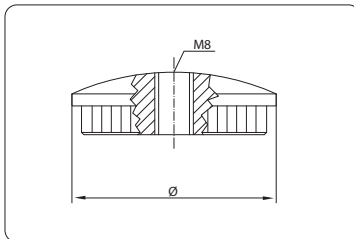

item no.	material	Ø	finish	
10204933A2	V2A (1.4301)	33,7 x 2,0	finish 240	2
10204942A2	V2A (1.4301)	42,4 x 2,0	finish 240	2
10205042A2*	V2A (1.4301)	42,4 x 2,6	finish 240	2
10204933A4	V4A	33,7 x 2,0	finish 240	2
10204942A4	V4A	42,4 x 2,0	finish 240	2

*with fins



handrail supports and accessories

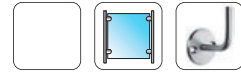

- end cap with through hole, variable height adjustable

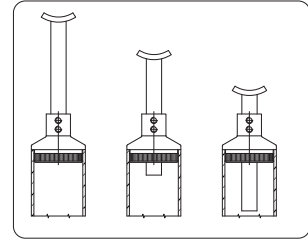
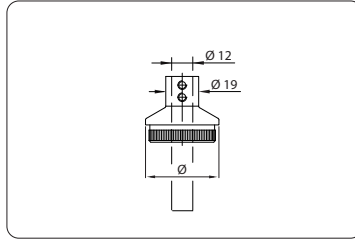

item no.	material	tube Ø	finish	
10205133A2	V2A (1.4301)	33,7 x 2,0	finish 240	2
10205142A2	V2A (1.4301)	42,4 x 2,0	finish 240	2
10205133A4	V4A	33,7 x 2,0	finish 240	2
10205142A4	V4A	42,4 x 2,0	finish 240	2

- handrail support with internal thread

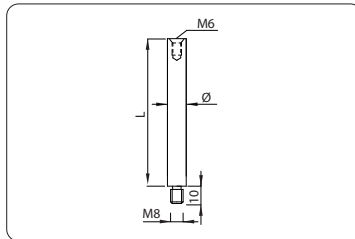

item no.	material	Ø	L	finish	
10205212A2	V2A (1.4301)	12	68	finish 240	2
10205312A2	V2A (1.4301)	12	115	finish 240	2
10205414A2	V2A (1.4301)	14	65	finish 240	2
10205412A4	V4A	12	65	finish 240	2



handrail supports and accessories

handrail support for welding

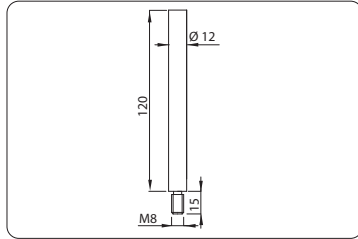

item no.	material	finish	
10205512A2	V2A (1.4301)	finish 240	2

weld socket

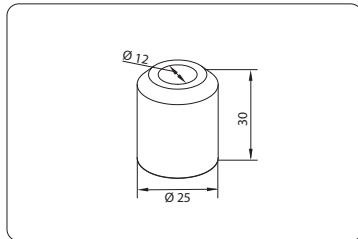

item no.	material	finish	
10205612A2	V2A (1.4301)	finish 240	2



handrail supports and accessories

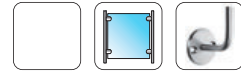

handrail support with joint and internal thread

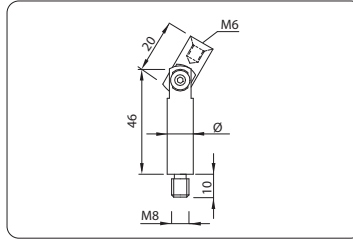

item no.	material	Ø	finish	
10205712A2	V2A (1.4301)	12	finish 240	2
10205712A4	V4A	12	finish 240	2
10205714A2	V2A (1.4301)	14	finish 240	2

handrail support, offset and with internal thread

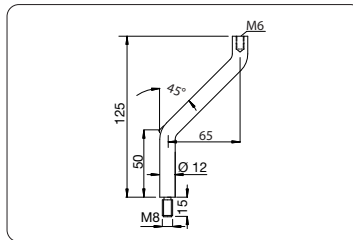

item no.	material	finish	
10205812A2	V2A (1.4301)	finish 240	2

adapter plate straight for square tube

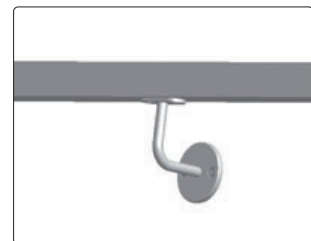
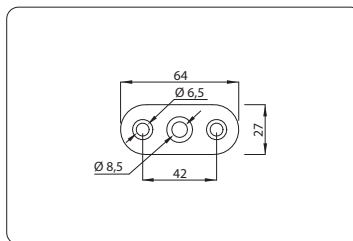

item no.	material	finish	
10205900A2	V2A (1.4301)	finish 240	2
10205900A4	V4A	finish 240	2



handrail supports and accessories

■ adapter plate straight for round tube

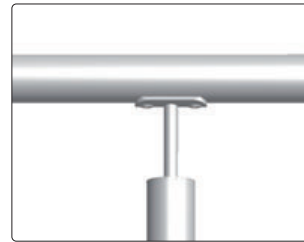
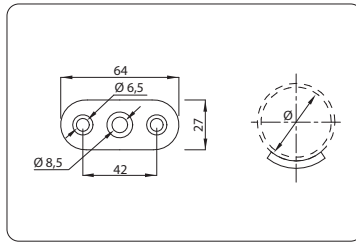

item no.	material	Ø	finish	
10206033A2	V2A (1.4301)	33,7 - 42,4	finish 240	2
10206048A2	V2A (1.4301)	48,3 - 60,3	finish 240	2
10206033A4	V4A	33,7 - 42,4	finish 240	2

■ adapter plate 135° for round tube

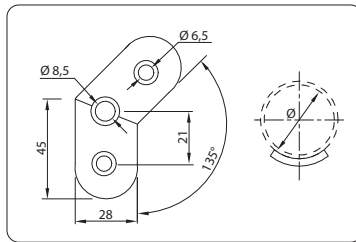

item no.	material	Ø	finish	
10206133A2	V2A (1.4301)	33,7 - 42,4	finish 240	2
10206148A2	V2A (1.4301)	48,3 - 60,3	finish 240	2

■ adapter plate 90° for round tube

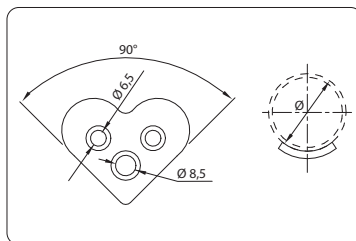

item no.	material	Ø	finish	
10206233A2	V2A (1.4301)	33,7 - 42,4	finish 240	2
10206248A2	V2A (1.4301)	48,3 - 60,3	finish 240	2